

AKUSTISCHER ZULUFTELEMENT VENEC VENEC VT 701

DURCHSCHNITT VT 300

AKUSTISCHER ZULUFTELEMENT MIT AUTOMATISCHER STEUERUNG DES LUFTDURCHFLUSSES VT 300

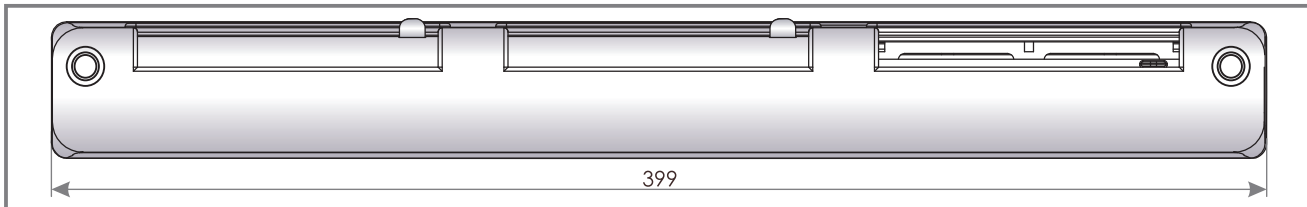
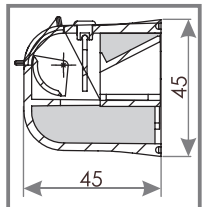

DURCHSCHNITT OZ 100

WETTERSCHUTZHAUBE STANDARD OZ100

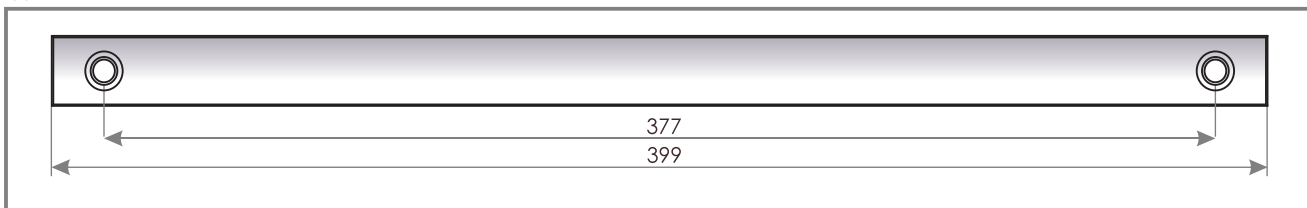
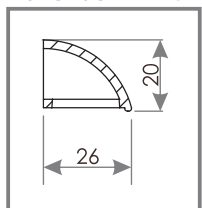

EIGENSCHAFTEN

Luftdurchfluss

24 m³/h ($\Delta p = 10$ Pa)

Schallschutz

$D_{n,e,w}(C;C_{tr}) = 36 (0; 0)$ dB

Diagramm 7. Abhängigkeit des Luftstromes q [m³/h] durchfließendes durch Lüfter VT 701 vom Unterdruck p [Pa]

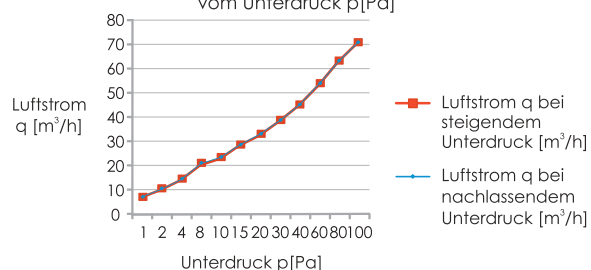

MONTAGEMÖGLICHKEIT

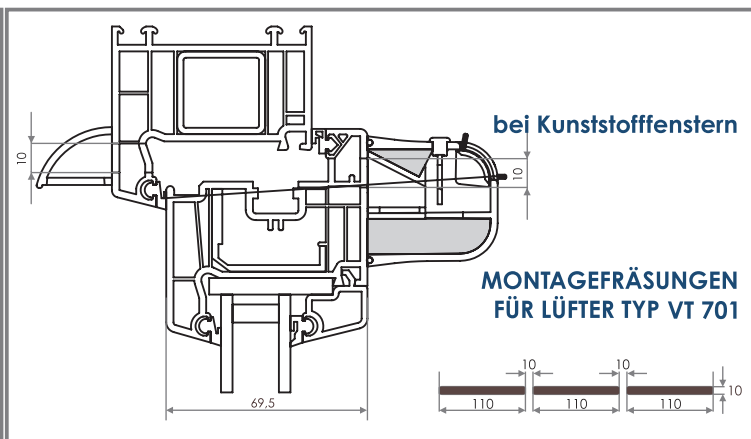
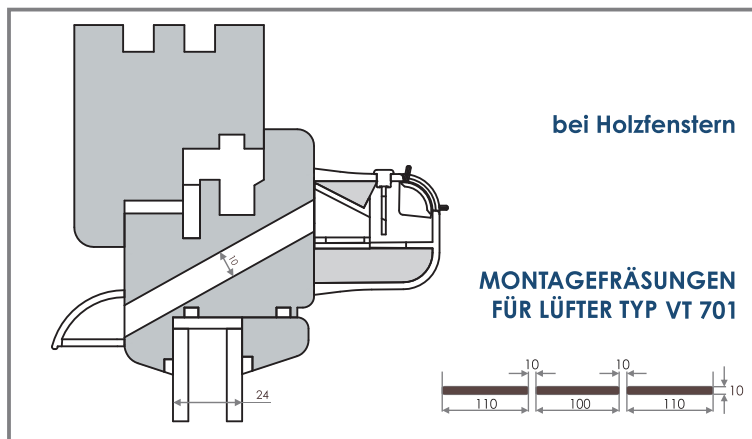

VENEC VT 701 - Farbauswahl

Symbol	VT701	VT712	VT713	VT714	VT715	VT722	VT723	VT724	VT725
Farbe innen	RAL 9003	RAL 9003	RAL 9003	RAL 9003	RAL 9003	RAL 8001	RAL 8017	RAL 7047	RAL 7016
Farbe aussen	RAL 9003	RAL 8001	RAL 8017	RAL 7047	RAL 7016	RAL 8001	RAL 8017	RAL 7047	RAL 7016